

Specification

Nominal Voltage	12V	
Nominal Capacity(10HR)	55.0AH	
Dimensions	Length	229±3mm (9.02 inches)
	Width	138±2mm (5.43 inches)
	Container Height	210±3mm (8.27 inches)
	Total Height (with Terminal)	230±3mm (9.06 inches)
Approx Weight	Approx 16.2 kg (35.7lbs)	
Terminal	T9	
Container Material	ABS	
Rated Capacity	57.2 AH/2.86A	(20hr, 1.80V/cell, 25°C/77°F)
	55.0 AH/5.50A	(10hr, 1.80V/cell, 25°C/77°F)
	47.3 AH/9.46A	(5hr, 1.75V/cell, 25°C/77°F)
	42.9 AH/14.3A	(3hr, 1.75V/cell, 25°C/77°F)
	33.6 AH/33.6A	(1hr, 1.60V/cell, 25°C/77°F)
Max. Discharge Current	660A (5s)	
Internal Resistance	Approx 7.5mΩ	
Operating Temp. Range	Discharge	-15~50°C (5~122°F)
	Charge	0~40°C (32~104°F)
	Storage	-15~40°C (5~104°F)
Nominal Operating Temp. Range	25±3°C (77±5°F)	
Cycle Use	Initial Charging Current less than 16.5A. Voltage	
	14.4V~15.0V at 25°C(77°F)Temp. Coefficient -30mV/°C	
Standby Use	No limit on Initial Charging Current Voltage	
	13.5V~13.8V at 25°C(77°F)Temp. Coefficient -20mV/°C	
Capacity affected by Temperature	40°C (104°F)	103%
	25°C (77°F)	100%
	0°C (32°F)	86%
Self Discharge	Leoch DJM series batteries may be stored for up to 6 months at 25°C(77°F) and then a freshening charge is required. For higher temperatures the time interval will be shorter.	



Applications

- ◆ All purpose
- ◆ Uninterruptable Power Supply (UPS)
- ◆ Electric Power System (EPS)
- ◆ Emergency backup power supply
- ◆ Emergency light
- ◆ Railway signal
- ◆ Aircraft signal
- ◆ Alarm and security system
- ◆ Electronic apparatus and equipment
- ◆ Communication power supply
- ◆ DC power supply
- ◆ Auto control system



Constant Current Discharge (Amperes) at 25 °C (77°F)

F.V/Time	5min	10min	15min	20min	30min	45min	1h	2h	3h	4h	5h	6h	8h	10h	20h
1.85V/cell	94.1	74.0	62.9	52.6	41.8	31.7	25.9	16.5	13.1	10.7	8.60	7.49	6.08	5.19	2.83
1.80V/cell	126.4	94.6	76.0	62.2	49.4	36.8	29.0	18.0	14.1	11.4	9.23	8.03	6.45	5.50	2.86
1.75V/cell	142.5	103.9	83.1	66.9	51.3	38.2	30.4	18.7	14.3	11.6	9.46	8.25	6.56	5.56	2.89
1.70V/cell	156.9	113.3	88.7	70.4	53.3	39.7	31.3	19.4	14.7	11.9	9.71	8.42	6.65	5.61	2.94
1.65V/cell	173.0	122.2	94.3	74.7	56.3	40.7	32.4	20.0	15.3	12.4	9.98	8.61	6.75	5.73	2.98
1.60V/cell	190.8	132.7	100.8	79.6	59.4	42.5	33.6	20.7	15.8	12.7	10.3	8.79	6.82	5.79	3.00

Constant Power Discharge (Watts/cell) at 25 °C (77°F)

F.V/Time	5min	10min	15min	20min	30min	45min	1h	2h	3h	4h	5h	6h	8h	10h	20h
1.85V/cell	172.1	136.7	117.4	99.2	79.7	60.9	50.0	32.1	25.5	20.9	16.9	14.7	12.0	10.3	5.61
1.80V/cell	228.6	172.6	140.0	115.6	92.7	70.2	55.7	34.8	27.2	22.2	18.0	15.7	12.7	10.9	5.66
1.75V/cell	252.2	186.6	151.0	123.1	95.4	72.2	58.0	35.9	27.6	22.6	18.4	16.1	12.9	11.0	5.70
1.70V/cell	270.0	198.8	159.0	128.4	98.7	74.8	59.7	37.3	28.4	23.1	18.9	16.4	13.0	11.1	5.81
1.65V/cell	293.6	212.6	167.8	135.4	103.3	76.0	61.2	38.1	29.4	23.8	19.3	16.7	13.2	11.3	5.88
1.60V/cell	316.3	225.5	176.5	142.7	108.3	78.8	63.1	39.2	30.2	24.5	19.9	17.0	13.3	11.4	5.90

Dimensions

T9 Terminal

Unit: mm

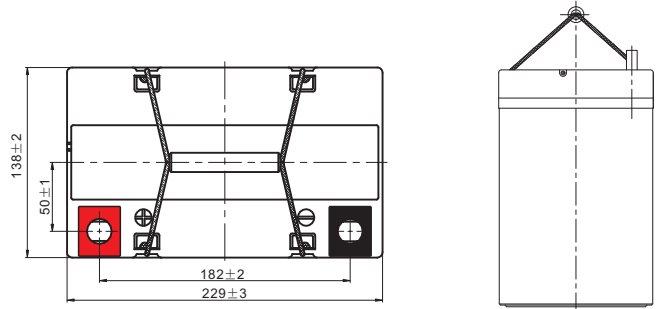
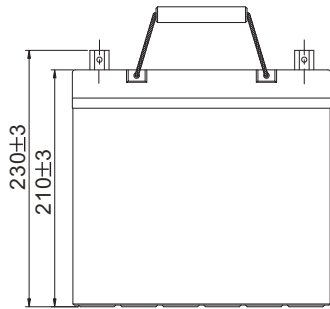
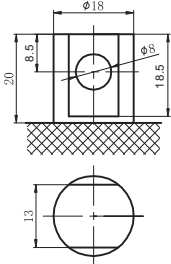

Discharge Characteristics

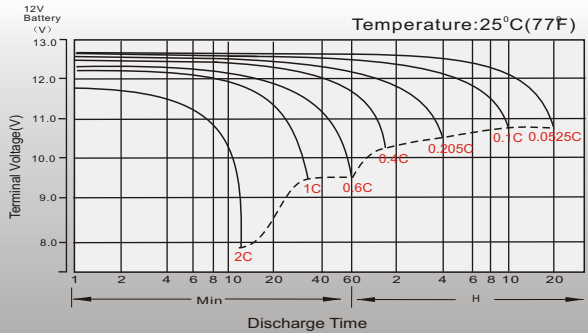

Float Charging Characteristics

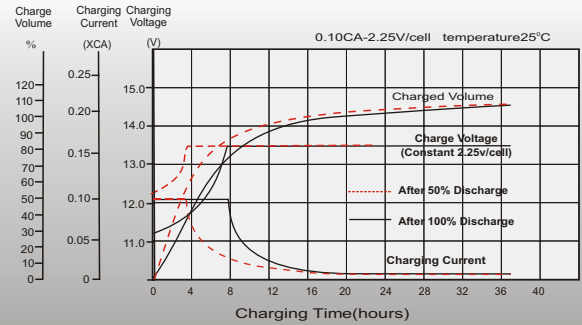

Temperature Effects in Relation to Battery Capacity

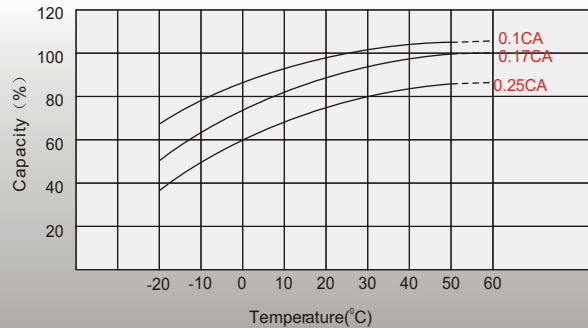

Effect of Temperature on Long Term Float Life

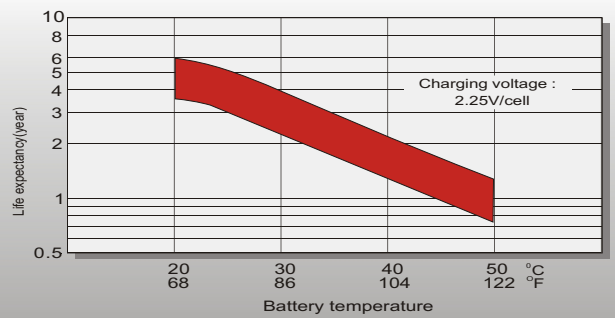

Cycle Life in Relation to Depth of Discharge

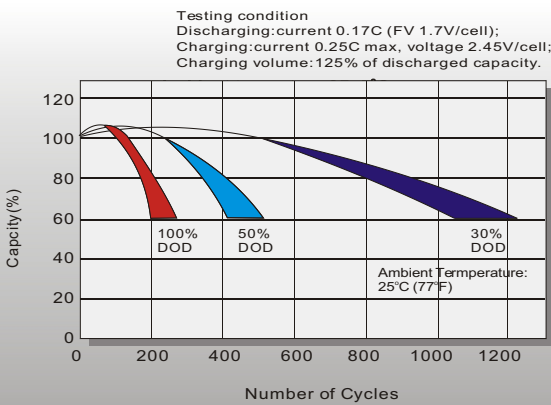

Self Discharge Characteristics

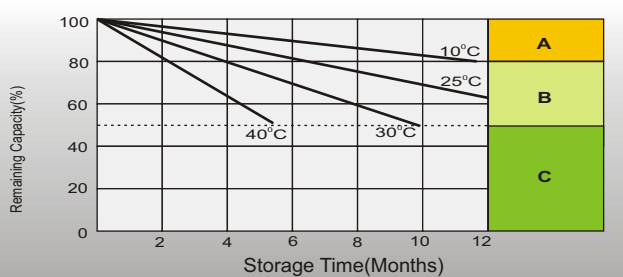

- A** No supplementary charge required (Carry out supplementary charge before use if 100% capacity is required.)
- B** Supplementary charge required before use. Optional charging way as below:
1. Charged for above 3 days at limited current 0.25CA and constant voltage 2.25V/cell.
2. Charged for above 20 hours at limited current 0.25CA and constant voltage 2.45V/cell.
3. Charged for 8-10 hours at limited current 0.05CA.
- C** Supplementary charge may often fail to recover the capacity. The battery should never be left standing till this is reached.

Sales Office

China sales office:

Add: 5th Floor, Xinbaohui Bldg., Nanhai Blvd.,
Nanshan, Shenzhen, China. 518052
Tel: +86-755-86036060 (100 lines)
Fax: +86-755-26067269
E-mail: export@leoch.com
Http://www.leoch.com

HongKong sales office:

Add: Workshop C, 33/F, TML Tower,
No. 3 Hoi Shing Road, Tsuen Wan,
New Territories, Hong Kong
Tel: +852 35786666
Fax: +852 21170016
E-mail: sales.hk@leoch.com

Singapore sales office:

Add: No. 1 Tech Park Crescent,
Singapore 638131
Tel: +65 68416629
Fax: +65 68443210
Email: sales.sg@leoch.com

North America sales office:

Add: 19751 Descartes, Unit A,
Foothill Ranch, CA 92610, USA
Tel: 949-588-5853
Fax: 949-588-5966
E-mail: sales@leoch.us
Http://www.leoch.com

Europe sales office:

Add: 9B Wheatstone Court, Waterwells
Business Park, Gloucester, GL2-2AQ,
UK United Kingdom
Tel: +44(0) 1452 729428 / 1452 729696
Fax: +44 (0)1452-690125
E-mail: Sales.Europe@leoch.com

DJM SERIES-General Purpose

DJM12100 (12V100AH)

Specification

Nominal Voltage	12V	
Nominal Capacity(10HR)	100.0AH	
Dimensions	Length	330±3mm (12.99 inches)
	Width	173±2mm (6.81 inches)
	Container Height	212±3mm (8.35 inches)
	Total Height (with Terminal)	220±3mm (8.66 inches)
Approx Weight	Approx 30.6 kg (67.5lbs)	
Terminal	T11	
Container Material	ABS	
Rated Capacity	104.0 AH/5.20A	(20hr, 1.80V/cell, 25°C/77°F)
	100.0 AH/10.0A	(10hr, 1.80V/cell, 25°C/77°F)
	88.0 AH/17.6A	(5hr, 1.75V/cell, 25°C/77°F)
	76.2 AH/25.4A	(3hr, 1.75V/cell, 25°C/77°F)
	63.8 AH/63.8A	(1hr, 1.60V/cell, 25°C/77°F)
Max. Discharge Current	1200A (5s)	
Internal Resistance	Approx 4.9mΩ	
Operating Temp. Range	Discharge	-15~50°C (5~122°F)
	Charge	0~40°C (32~104°F)
	Storage	-15~40°C (5~104°F)
Nominal Operating Temp. Range	25±3°C (77±5°F)	
Cycle Use	Initial Charging Current less than 30.0A. Voltage	
	14.4V~15.0V at 25°C(77°F)Temp. Coefficient -30mV/°C	
Standby Use	No limit on Initial Charging Current Voltage	
	13.5V~13.8V at 25°C(77°F)Temp. Coefficient -20mV/°C	
Capacity affected by Temperature	40°C (104°F)	103%
	25°C (77°F)	100%
	0°C (32°F)	86%
Self Discharge	Leoch DJM series batteries may be stored for up to 6 months at 25°C(77°F) and then a freshening charge is required. For higher temperatures the time interval will be shorter.	



Applications

- ◆ All purpose
- ◆ Uninterruptable Power Supply (UPS)
- ◆ Electric Power System (EPS)
- ◆ Emergency backup power supply
- ◆ Emergency light
- ◆ Railway signal
- ◆ Aircraft signal
- ◆ Alarm and security system
- ◆ Electronic apparatus and equipment
- ◆ Communication power supply
- ◆ DC power supply
- ◆ Auto control system



Constant Current Discharge (Amperes) at 25 °C (77°F)

F.V/Time	5min	10min	15min	20min	30min	45min	1h	2h	3h	4h	5h	6h	8h	10h	20h
1.85V/cell	173.6	146.4	130.2	115.3	87.5	65.2	52.4	31.3	23.5	19.2	16.4	14.4	11.6	9.65	5.13
1.80V/cell	210.0	167.6	143.7	123.5	92.1	68.7	55.1	33.1	24.6	20.2	17.2	15.0	12.0	10.0	5.20
1.75V/cell	237.0	186.3	154.0	130.8	96.5	71.3	57.1	34.4	25.4	20.7	17.6	15.3	12.2	10.1	5.29
1.70V/cell	261.6	199.5	165.1	138.9	101.8	74.6	59.5	35.3	26.0	21.2	17.9	15.6	12.4	10.2	5.34
1.65V/cell	291.7	215.1	178.5	146.6	106.7	77.4	61.9	36.3	26.7	21.7	18.3	15.9	12.6	10.3	5.40
1.60V/cell	330.8	232.5	188.5	154.3	112.3	80.5	63.8	37.5	27.6	22.2	18.6	16.2	12.7	10.5	5.45

Constant Power Discharge (Watts/cell) at 25 °C (77°F)

F.V/Time	5min	10min	15min	20min	30min	45min	1h	2h	3h	4h	5h	6h	8h	10h	20h
1.85V/cell	322.5	274.9	247.1	220.5	168.5	126.4	102.2	60.8	45.7	37.5	32.2	28.2	22.9	19.1	10.2
1.80V/cell	386.4	312.2	271.0	235.1	176.8	132.7	107.2	63.8	47.7	39.2	33.6	29.4	23.7	19.8	10.3
1.75V/cell	431.3	344.9	288.7	247.8	184.3	137.3	110.8	66.0	49.1	40.1	34.3	29.9	24.0	19.9	10.4
1.70V/cell	470.9	366.5	307.7	261.8	193.6	143.0	115.0	67.6	50.1	41.0	34.8	30.4	24.3	20.1	10.5
1.65V/cell	519.3	391.4	330.2	274.5	201.9	147.7	119.1	69.2	51.3	41.8	35.3	30.8	24.6	20.3	10.6
1.60V/cell	578.9	418.2	345.1	286.6	211.1	152.9	122.4	71.1	52.7	42.6	35.9	31.3	24.8	20.5	10.7

Specifications subject to change without notice.



Dimensions

T11 Terminal

Unit: mm

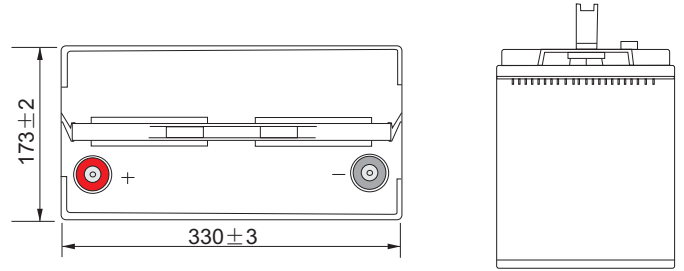
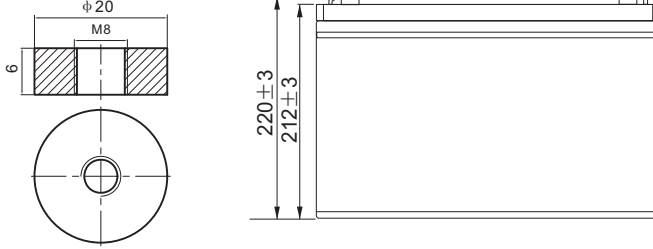

Discharge Characteristics

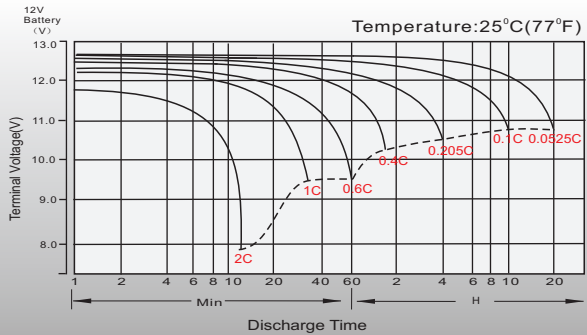

Float Charging Characteristics

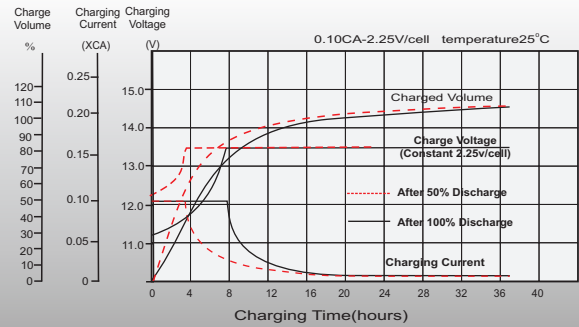

Temperature Effects in Relation to Battery Capacity

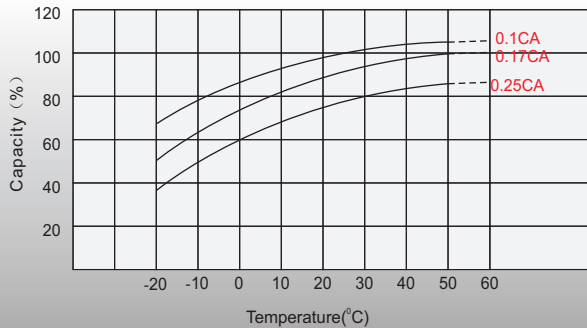

Effect of Temperature on Long Term Float Life

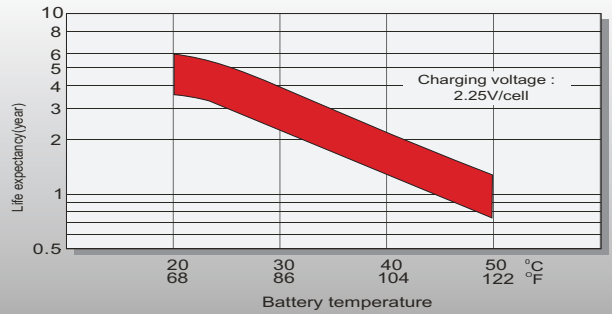

Cycle Life in Relation to Depth of Discharge

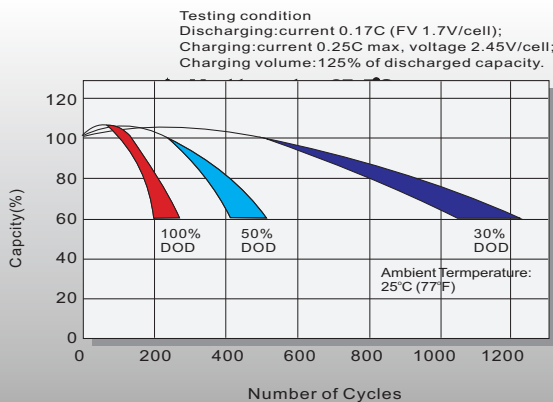

Self Discharge Characteristics

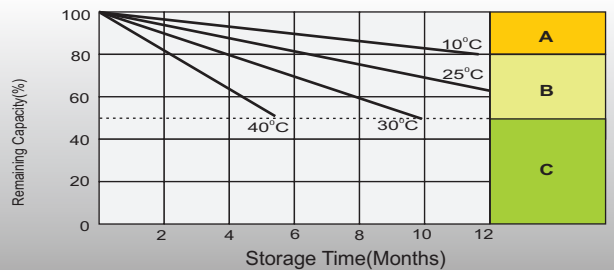

A No supplementary charge required (Carry out supplementary charge before use if 100% capacity is required.)

Supplementary charge required before use. Optional charging way as below:
B 1. Charged for above 3 days at limited current 0.25CA and constant voltage 2.25V/cell.
 2. Charged for above 20 hours at limited current 0.25CA and constant voltage 2.45V/cell.
 3. Charged for 8-10 hours at limited current 0.05CA.

C Supplementary charge may often fail to recover the capacity. The battery should never be left standing till this is reached.

Sales Office

China sales office:

Add: 5th Floor, Xinbaohui Bldg., Nanhai Blvd.,
 Nanshan, Shenzhen, China. 518052
 Tel: +86-755-86036060 (100 lines)
 Fax: +86-755-26067269
 E-mail: export@leoch.com
 Http://www.leoch.com

HongKong sales office:

Workshop C, 33/F, TML Tower,
 No. 3 Hoi Shing Road, Tsuen Wan,
 New Territories, Hong Kong
 Tel: +852 35786666
 Fax: +852 21170016
 E-mail: sales.hk@leoch.com

Singapore sales office:

Add: No. 1 Tech Park Crescent,
 Singapore 638131
 Tel: +65 68636078
 Fax: +65 68636079
 Email sales.sg@leoch.com
 Http://www.leoch.com

North America sales office:

Add: 19751 Descartes, Unit A,
 Foothill Ranch, CA 92610, USA
 Tel: 949-588-5853
 Fax: 949-588-5966
 E-mail: sales@leoch.us
 Http://www.leoch.com

Europe sales office:

Add: 9B Wheatstone Court, Waterwells
 Business Park, Gloucester, GL2-2AQ,
 UK United Kingdom
 Tel: +44(0) 1452 729428 / 1452 729696
 Fax: +44 (0)1452-690125
 E-mail: Sales.Europe@leoch.com



Specification

Nominal Voltage	12V	
Nominal Capacity(10HR)	150.0AH	
Dimension	Length	483±3mm (19.02 inches)
	Width	170±2mm (6.69 inches)
	Container Height	238.5±3mm (9.39 inches)
	Total Height (with Terminal)	238.5±3mm (9.39 inches)
Approx Weight	Approx 47.2 Kg (104.08 lbs)	
Terminal	T11	
Container Material	ABS	
Rated Capacity	160.5 AH/8.03A	(20hr, 1.80V/cell, 25°C/77°F)
	150.0 AH/15.0A	(10hr, 1.80V/cell, 25°C/77°F)
	130.5 AH/26.1A	(5hr, 1.75V/cell, 25°C/77°F)
	117.0 AH/39.0A	(3hr, 1.75V/cell, 25°C/77°F)
	93.0 AH/93.0A	(1hr, 1.60V/cell, 25°C/77°F)
Max. Discharge Current	1500A (5s)	
Internal Resistance	Approx 3.5mΩ	
Operating Temp. Range	Discharge	-15~50°C (5~122°F)
	Charge	0~40°C (32~104°F)
	Storage	-15~40°C (5~104°F)
Nominal Operating Temp. Range	25±3°C (77±5°F)	
Cycle Use	Initial Charging Current less than 45.0A. Voltage 14.4V~15.0V at 25°C(77°F)Temp. Coefficient -30mV/°C	
	Standby Use: No limit on Initial Charging Current Voltage 13.5V~13.8V at 25°C(77°F)Temp. Coefficient -20mV/°C	
Capacity affected by Temperature	40°C (104°F)	103%
	25°C (77°F)	100%
	0°C (32°F)	86%
Self Discharge	Leoch DJM series batteries may be stored for up to 6 months at 25°C(77°F) and then a freshening charge is required. For higher temperatures the time interval will be shorter.	

Applications

- ◆ All purpose
- ◆ Uninterruptable Power Supply (UPS)
- ◆ Electric Power System (EPS)
- ◆ Emergency backup power supply
- ◆ Emergency light
- ◆ Railway signal
- ◆ Aircraft signal
- ◆ Alarm and security system
- ◆ Electronic apparatus and equipment
- ◆ Communication power supply
- ◆ DC power supply
- ◆ Auto control system



Constant Current Discharge (Amperes) at 25 °C (77°F)

F.V/Time	10min	15min	20min	30min	45min	1h	2h	3h	4h	5h	6h	8h	10h	20h
1.85V/cell	175.5	147.6	131.0	108.6	83.8	71.7	46.4	34.9	28.6	24.1	21.1	16.9	14.5	7.76
1.80V/cell	200.8	165.7	144.8	118.0	90.4	75.7	49.9	37.5	30.4	25.5	22.3	17.8	15.0	8.03
1.75V/cell	228.1	186.8	160.0	128.2	98.6	82.5	51.9	39.0	31.4	26.1	23.0	18.4	15.4	8.23
1.70V/cell	257.6	207.3	176.6	139.9	106.2	87.3	54.7	41.1	32.9	27.6	24.1	19.2	16.0	8.44
1.65V/cell	276.6	221.9	187.9	147.7	112.4	90.3	56.7	42.7	34.1	28.5	25.0	19.8	16.4	8.70
1.60V/cell	304.3	243.0	204.1	157.6	116.8	93.0	58.1	43.8	34.9	29.2	25.5	20.2	16.8	8.84

Constant Power Discharge (Watts/cell) at 25 °C (77°F)

F.V/Time	10min	15min	20min	30min	45min	1h	2h	3h	4h	5h	6h	8h	10h	20h
1.85V/cell	327.7	278.4	249.5	209.2	162.8	139.7	91.1	68.7	56.5	47.6	41.9	33.7	29.1	15.5
1.80V/cell	370.6	308.4	271.8	223.7	174.2	146.7	97.3	73.4	59.7	50.3	44.2	35.4	29.9	16.0
1.75V/cell	414.2	343.4	297.5	241.1	188.2	159.2	100.8	76.1	61.6	51.3	45.4	36.5	30.7	16.4
1.70V/cell	457.4	375.7	326.0	261.8	202.0	167.9	105.9	79.9	64.2	54.1	47.5	38.0	31.9	16.8
1.65V/cell	486.7	399.2	344.2	274.1	211.9	172.5	109.2	82.8	66.5	55.7	49.0	39.2	32.7	17.3
1.60V/cell	523.4	430.1	369.9	290.4	219.0	176.7	111.4	84.5	67.8	56.8	49.9	39.8	33.3	17.6

Specifications subject to change without notice.



Dimensions

T11 Terminal

Unit: mm

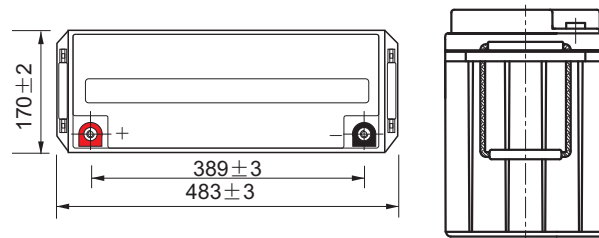
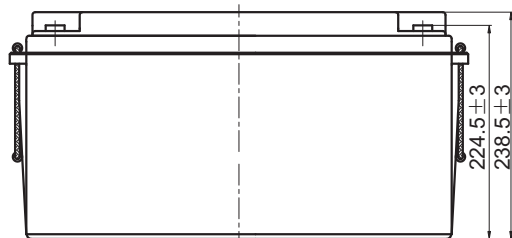
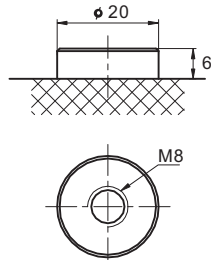

Discharge Characteristics

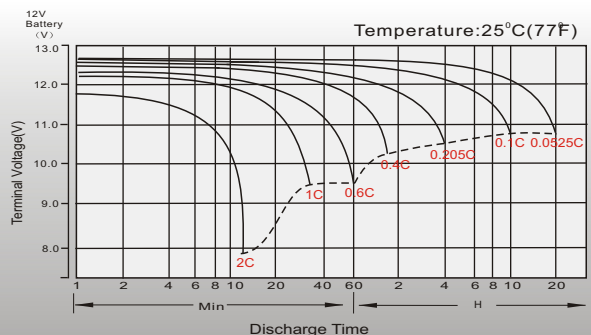

Float Charging Characteristics

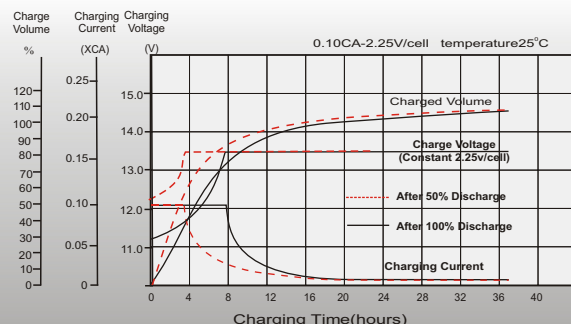

Temperature Effects in Relation to Battery Capacity

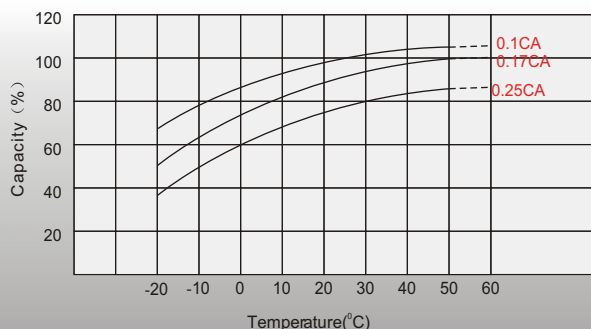

Effect of Temperature on Long Term Float Life

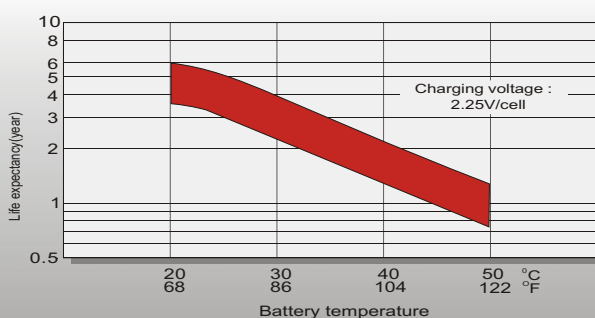

Cycle Life in Relation to Depth of Discharge

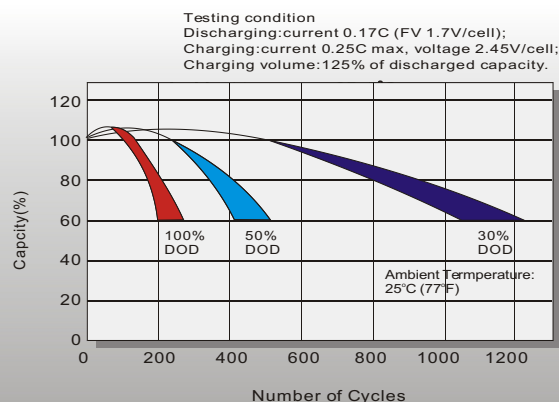

Self Discharge Characteristics

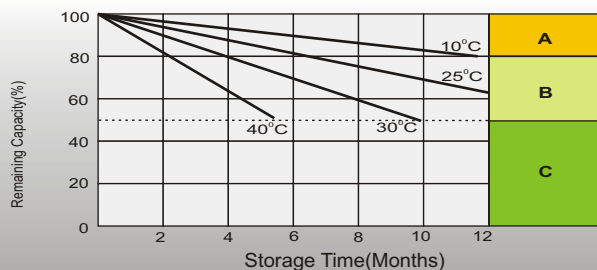

A No supplementary charge required (Carry out supplementary charge before use if 100% capacity is required.)

Supplementary charge required before use. Optional charging way as below:
1. Charged for above 3 days at limited current 0.25CA and constant voltage 2.25V/cell.
2. Charged for above 20 hours at limited current 0.25CA and constant voltage 2.45V/cell.
3. Charged for 8-10 hours at limited current 0.05CA.

C Supplementary charge may often fail to recover the capacity. The battery should never be left standing till this is reached.

Sales Office

China sales office:

Add: 5th Floor, Xinbaohui Bldg., Nanshai Blvd.,
Nanshan, Shenzhen, China. 518052
Tel: +86-755-86036060 (100 lines)
Fax: +86-755-26067269
E-mail: export@leoch.com
Http://www.leoch.com

HongKong sales office:

Add: Workshop C, 33/F, TML Tower,
No. 3 Hoi Shing Road, Tsuen Wan,
New Territories, Hong Kong
Tel: +852 35786666
Fax: +852 21170016
E-mail: sales.hk@leoch.com

Singapore sales office:

Add: No. 1 Tech Park Crescent,
Singapore 638131
Tel: +65 68416629
Fax: +65 68443210
Email: sales.sg@leoch.com

North America sales office:

Add: 19751 Descartes, Unit A,
Foothill Ranch, CA 92610, USA
Tel: 949-588-5853
Fax: 949-588-5966
E-mail: sales@leoch.us
Http://www.leoch.com

Europe sales office:

Add: 9B Wheatstone Court, Waterwells
Business Park, Gloucester, GL2-2AQ,
UK United Kingdom
Tel: +44(0) 1452 729428 / 1452 729696
Fax: +44 (0)1452-690125
E-mail: Sales.Europe@leoch.com

Nominal Voltage	12V	
Nominal Capacity(10HR)	200.0AH	
Dimension	Length	522±3mm (20.55 inches)
	Width	240±3mm (9.45 inches)
	Container Height	218±3mm (8.58 inches)
	Total Height (with Terminal)	224±3mm (8.81 inches)
Approx Weight	Approx 64.0 Kg (141.12 lbs)	
Terminal	T11	
Container Material	ABS	
Rated Capacity	214.0 AH/10.7A	(20hr, 1.80V/cell, 25°C/77°F)
	200.0 AH/20.0A	(10hr, 1.80V/cell, 25°C/77°F)
	174.0 AH/34.8A	(5hr, 1.75V/cell, 25°C/77°F)
	156.0 AH/52.0A	(3hr, 1.75V/cell, 25°C/77°F)
	124.0 AH/124.0A	(1hr, 1.60V/cell, 25°C/77°F)
Max. Discharge Current	2000A (5s)	
Internal Resistance	Approx 2.7mΩ	
Operating Temp. Range	Discharge : -15~50°C (5~122°F)	
	Charge : 0~40°C (32~104°F)	
	Storage : -15~40°C (5~104°F)	
Nominal Operating Temp. Range	25±3°C (77±5°F)	
Cycle Use	Initial Charging Current less than 60.0A. Voltage 14.4V~15.0V at 25°C(77°F)Temp. Coefficient -30mV/°C	
	Standby Use No limit on Initial Charging Current Voltage 13.5V~13.8V at 25°C(77°F)Temp. Coefficient -20mV/°C	
Capacity affected by Temperature	40°C (104°F)	103%
	25°C (77°F)	100%
	0°C (32°F)	86%
Self Discharge	Leoch DJM series batteries may be stored for up to 6 months at 25°C(77°F) and then a freshening charge is required. For higher temperatures the time interval will be shorter.	



Applications

- ◆ All purpose
- ◆ Uninterruptable Power Supply (UPS)
- ◆ Electric Power System (EPS)
- ◆ Emergency backup power supply
- ◆ Emergency light
- ◆ Railway signal
- ◆ Aircraft signal
- ◆ Alarm and security system
- ◆ Electronic apparatus and equipment
- ◆ Communication power supply
- ◆ DC power supply
- ◆ Auto control system



F.V/Time	10min	15min	20min	30min	45min	1h	2h	3h	4h	5h	6h	8h	10h	20h
1.85V/cell	234.0	196.8	174.6	144.8	111.7	95.6	61.9	46.5	38.1	32.1	28.1	22.5	19.4	10.3
1.80V/cell	267.8	221.0	193.0	157.3	120.5	100.9	66.5	50.0	40.5	34.0	29.8	23.7	20.0	10.7
1.75V/cell	304.1	249.1	213.3	170.9	131.5	110.0	69.2	52.0	41.9	34.8	30.7	24.5	20.5	11.0
1.70V/cell	343.5	276.3	235.5	186.6	141.6	116.4	72.9	54.7	43.8	36.8	32.2	25.6	21.3	11.3
1.65V/cell	368.8	295.9	250.5	196.9	149.9	120.4	75.6	56.9	45.5	38.0	33.3	26.4	21.9	11.6
1.60V/cell	405.8	324.1	272.1	210.1	155.7	124.0	77.5	58.4	46.5	38.9	34.0	26.9	22.4	11.8

F.V/Time	10min	15min	20min	30min	45min	1h	2h	3h	4h	5h	6h	8h	10h	20h
1.85V/cell	436.9	371.2	332.6	278.9	217.0	186.3	121.4	91.7	75.3	63.5	55.8	45.0	38.7	20.7
1.80V/cell	494.1	411.2	362.4	298.3	232.3	195.6	129.7	97.9	79.6	67.0	58.9	47.2	39.9	21.4
1.75V/cell	552.3	457.9	396.7	321.5	251.0	212.3	134.4	101.4	82.1	68.4	60.6	48.6	40.9	21.9
1.70V/cell	609.8	501.0	434.6	349.1	269.3	223.9	141.3	106.6	85.6	72.2	63.4	50.6	42.5	22.4
1.65V/cell	648.9	532.3	458.9	365.4	282.5	230.0	145.6	110.4	88.6	74.2	65.4	52.2	43.6	23.1
1.60V/cell	697.8	573.5	493.2	387.2	292.0	235.6	148.6	112.7	90.3	75.8	66.5	53.0	44.4	23.4

Specifications subject to change without notice.



Dimensions

T11 Terminal

Unit: mm

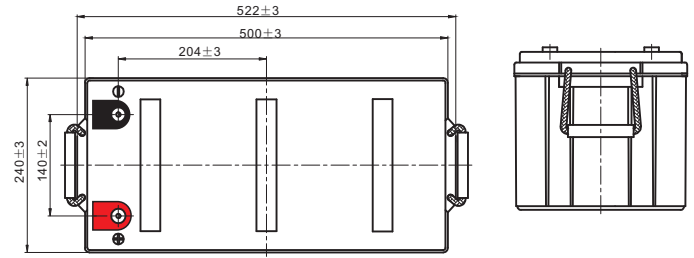
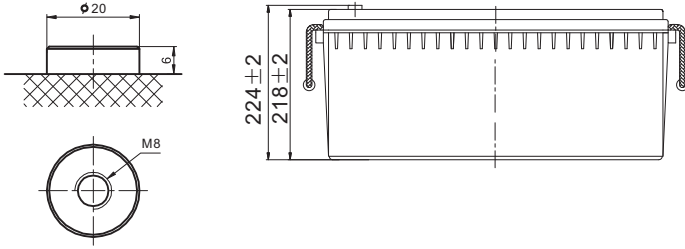

Discharge Characteristics

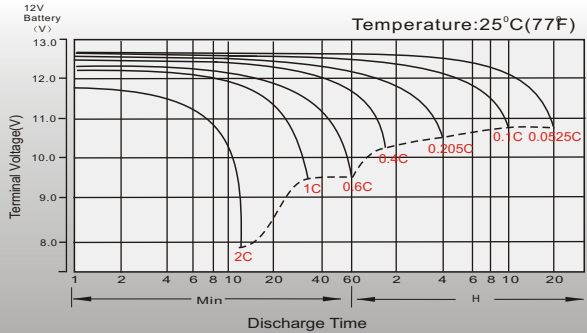

Float Charging Characteristics

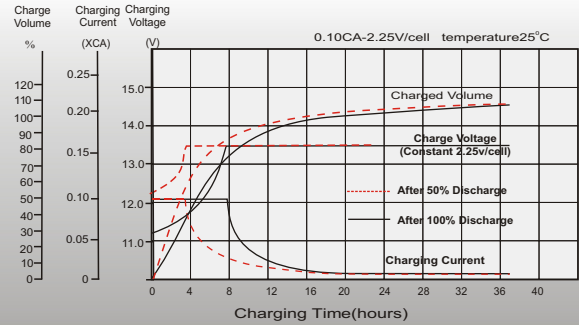

Temperature Effects in Relation to Battery Capacity

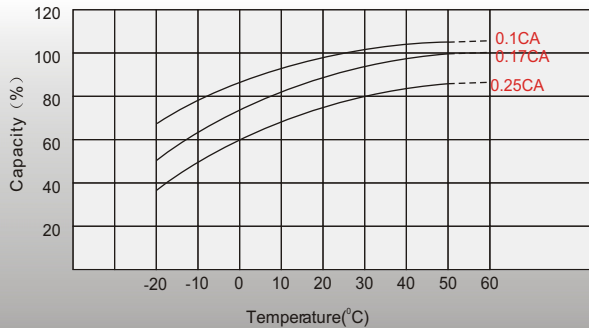

Effect of Temperature on Long Term Float Life

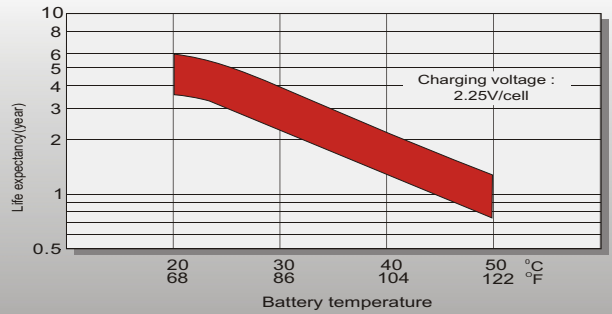

Cycle Life in Relation to Depth of Discharge

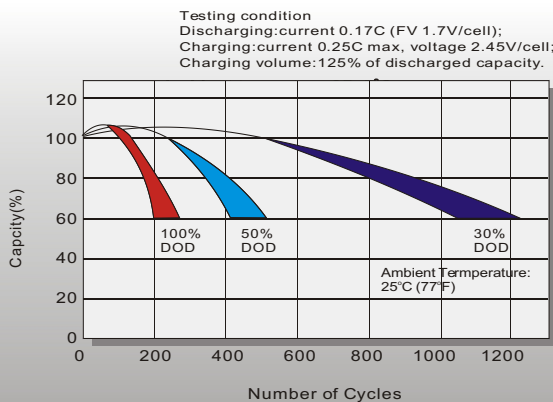

Self Discharge Characteristics

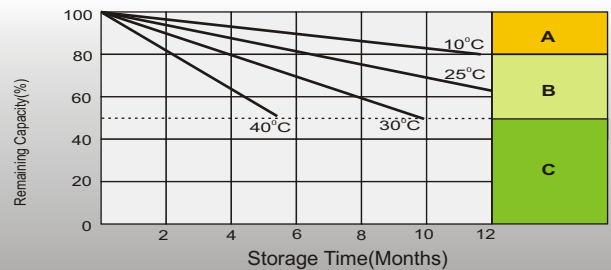

- A** No supplementary charge required (Carry out supplementary charge before use if 100% capacity is required.)
- B** Supplementary charge required before use. Optional charging way as below:
 1. Charged for above 3 days at limited current 0.25CA and constant voltage 2.25V/cell.
 2. Charged for above 20 hours at limited current 0.25CA and constant voltage 2.45V/cell.
 3. Charged for 8-10 hours at limited current 0.05CA.
- C** Supplementary charge may often fail to recover the capacity. The battery should never be left standing till this is reached.

Sales Office

China sales office:

Add: 5th Floor, Xinbaohui Bldg., Nanhai Blvd.,
Nanshan, Shenzhen, China. 518052
Tel: +86-755-86036060 (100 lines)
Fax: +86-755-26067269
E-mail: export@leoch.com
Http://www.leoch.com

HongKong sales office:

Add: Workshop C, 33/F, TML Tower,
No. 3 Hoi Shing Road, Tsuen Wan,
New Territories, Hong Kong
Tel: +852 35786666
Fax: +852 21170016
E-mail: sales.hk@leoch.com

Singapore sales office:

Add: No. 1 Tech Park Crescent,
Singapore 638131
Tel: +65 68416629
Fax: +65 68443210
Email: sales.sg@leoch.com

North America sales office:

Add: 19751 Descartes, Unit A,
Foothill Ranch, CA 92610, USA
Tel: 949-588-5853
Fax: 949-588-5966
E-mail: sales@leoch.us
Http://www.leoch.com

Europe sales office:

Add: 9B Wheatstone Court, Waterwells
Business Park, Gloucester, GL2-2AQ,
UK United Kingdom
Tel: +44(0) 1452 729428 / 1452 729696
Fax: +44 (0)1452-690125
E-mail: Sales.Europe@leoch.com